



# **S17, S17 Pro, T17 Server Installation Guide**

**Document Version 0.1**

**May. 2019**

© Copyright Bitmaintech Pte.Ltd. 2007 – 2019. All rights reserved.

Bitmaintech Pte.Ltd. (Bitmain) reserves the right to make corrections, modifications, enhancements, improvements, and other changes to its products and services at any time and to discontinue any product or service without notice.

Customers should obtain the latest relevant information before placing orders and should verify that such information is current and complete. All products are sold subject to Bitmain's terms and conditions of sale supplied at the time of order acknowledgment.

Bitmain warrants performance of its products to the specifications applicable at the time of sale in accordance with Bitmain's standard warranty. Testing and other quality control techniques are used to the extent Bitmain deems necessary to support this warranty. Except where mandated by government requirements, testing of all parameters of each product is not necessarily performed.

Bitmain assumes no liability for third-party applications assistance. Customers are responsible for their products and applications using Bitmain components. To minimize the risks associated with customer products and applications, customers should provide adequate design and operating safeguards.

Bitmain does not warrant or represent that any license, either express or implied, is granted under any Bitmain patent right, copyright or other Bitmain intellectual property right relating to any combination, machine, or process in which Bitmain products or services are used. Information published by Bitmain regarding third-party products or services does not constitute a license from Bitmain to use such products or services or a warranty or endorsement thereof. Use of such information may require a license from a third party under the patents or other intellectual property of the third party, or a license from Bitmain under the patents or other intellectual property of Bitmain.

Resale of Bitmain products or services with statements different from or beyond the parameters stated by Bitmain for that product or service voids all express and any implied warranties for the associated Bitmain product or service and is an unfair and deceptive business practice. Bitmain is not responsible or liable for any such statements.

All company and brand products and service names are trademarks or registered trademarks of their respective holders.

All text and figures included in this publication are the exclusive property of Bitmaintech Pte.Ltd. (Bitmain), and may not be copied, reproduced, or used in any way without the express written permission of Bitmain. Information in this document is subject to change without notice and does not represent a commitment on the part of Bitmain. Although the information in this document has been carefully reviewed, Bitmain does not warrant it to be free of errors or omissions. Bitmain reserves the right to make corrections, updates, revisions or changes to the information in this document.

Bitmaintech Pte.Ltd.  
Tel:+86-400-890-8855  
[www.bitmain.com](http://www.bitmain.com)

### Table of Contents

|  |           |
|--|-----------|
| <b>1. Overview.....</b>                      | <b>4</b>  |
| 1.1 S17, S17 Pro, T17 Server Components..... | 5         |
| 1.2 Specifications.....                      | 7         |
| <b>2. Setting Up the Server.....</b>         | <b>17</b> |
| <b>3. Configuring the Server.....</b>        | <b>19</b> |
| <b>4. Monitoring Your Server.....</b>        | <b>21</b> |
| <b>5. Administering Your Server.....</b>     | <b>23</b> |
| 5.1 Checking Your Firmware Version.....      | 23        |
| 5.2 Upgrading Your System.....               | 24        |
| 5.3 Modifying Your Password.....             | 25        |
| 5.4 Restoring Initial Settings.....          | 25        |
| <b>Environmental Requirements.....</b>       | <b>26</b> |
| <b>Regulations.....</b>                      | <b>28</b> |

## 1. Overview

The S17, S17 Pro, T17 servers are Bitmain's newest versions in the 17 server series. Power supply APW9 is part of S17, S17 Pro, T17 servers. All S17, S17 Pro, T17 servers are tested and configured prior to shipping to ensure easy set up. Here takes pictures of S17 server as examples:



Front View



Back View



### Placement

**Caution:**

- 1.The equipment must be connected to an earthed mains socket-outlet. The socket-outlet shall be installed near the equipment and shall be easily accessible.
- 2.The equipment has two power inputs, only by connecting those two power supply sockets simultaneously can the equipment run. When the equipment is powered off, be sure to power off all power inputs.
- 3.Please refer to the layout above to place your goods in usage in case of any damage.

## 1.1 S17, S17 Pro, T17 Server Components

The main components and controller front panel of S17, S17 Pro, T17 servers are shown in the following figure (here takes pictures of S17 server as examples):

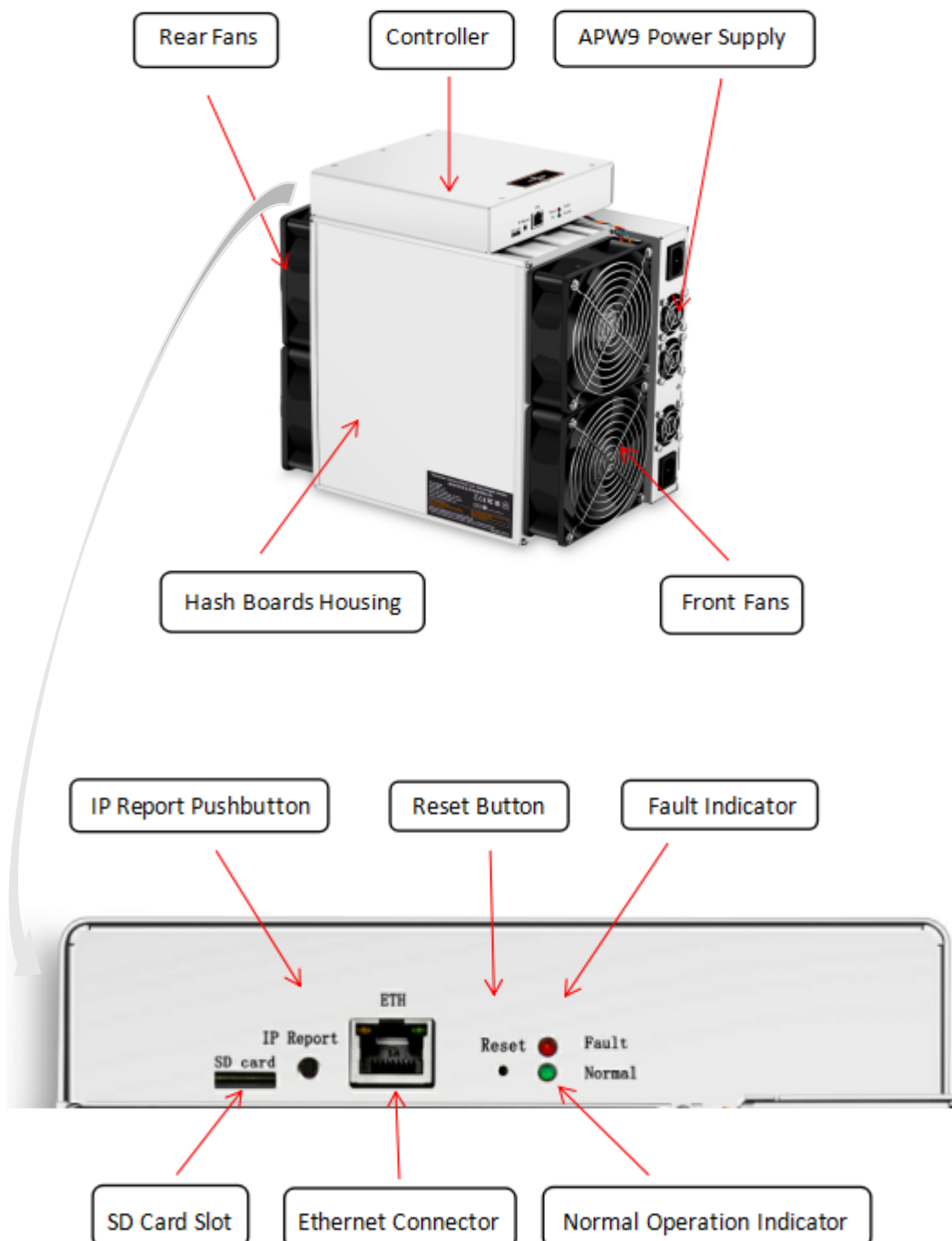

## APW9 Power Supply:

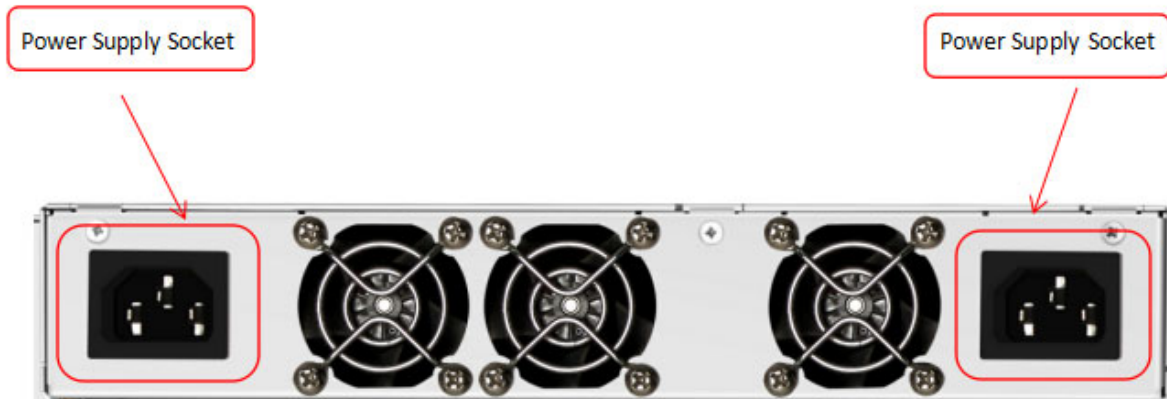

### Note:



1.Power supply APW9 is part of S17, S17 Pro, T17 servers. For detailed parameters, please refer to the specifications below.

2.Additional two power cords are needed.

## 1.2 Specifications

**Model No.: 240-Aa**

**Version: S17-53T**

| Product Glance                                 | Value          |        |
|--|----------------|--------|
|  | Low Power      | Normal |
| Crypto Algorithm/Coins                         | SHA256/BTC/BCH |        |
| Hashrate, TH/s                                 | 35~50.00       | 53.00  |
| Reference power on wall, Watt                  | 1470~2100      | 2385   |
| Reference power efficiency on wall @25°C, J/TH | 42.00          | 45.00  |

| Detailed Characteristics                             | Value                 |           |                      |
|--|-----------------------|-----------|----------------------|
|  | Min                   | Typ       | Max                  |
| <b>Hashrate &amp; Power</b>                          |                       |           |                      |
| Hashrate, TH/s                                       | Low Power             | 35~50.00  | +3% <sup>(1-1)</sup> |
|  | Normal                | 53.00     | 55.95                |
| Power efficiency on wall @25°C, J/TH                 | Low Power             | 42.00     | 46.20                |
|  | Normal                | 45.00     | 49.50                |
| Power efficiency on wall @40°C, J/TH                 | Low Power             | 43.81     | 48.19                |
|  | Normal                | 46.47     | 51.11                |
| Power on wall, Watt <sup>(1-2)</sup>                 | Low Power             | 1470~2100 | 2482                 |
|  | Normal                | 2385      | 2860                 |
| Power supply AC input voltage, Volt <sup>(1-3)</sup> | 200                   | 220       | 240                  |
| Power supply AC input current, Amp <sup>(1-4)</sup>  | Low Power             | 6.68~9.55 | 12.41                |
|  | Normal                | 10.84     | 14.30                |
| Power supply Input AC Frequency Range, Hz            | 47                    | 50        | 63                   |
| <b>Hardware Configuration</b>                        |                       |           |                      |
| Quantity of hash chips                               | 144                   |           |                      |
| Quantity of hash boards                              | 3                     |           |                      |
| Networking connection mode                           | RJ45 Ethernet 10/100M |           |                      |

|  |                   |     |    |     |
|--|-------------------|-----|----|-----|
| Server Size (Length*Width*Height, w/o package),mm <sup>(2-1)</sup> | 298.2*178.0*296.6 |     |    |     |
| Net weight, kg <sup>(2-2)</sup>                                    | 9.50              |     |    |     |
| Noise, dBA @25°C <sup>(2-3)</sup>                                  |                   |     |    | 82  |
| <b>Environmental Requirements</b>                                  |                   |     |    |     |
| Operation temperature,°C   |                   | 0   | 25 | 40  |
| Storage temperature,°C   |                   | -20 | 25 | 70  |
| Operation humidity, RH(no condensation)                            |                   | 10% |    | 90% |

**Notes:**

- (1-1) In Low Power Mode, Max Hashrate is about **Typ Hashrate \*103%**
- (1-2) Min condition: 25°C, min J/TH, typical Hashrate  
Max condition: 40°C, max J/TH, max Hashrate
- (1-3) Caution: Wrong input voltage may probably cause server damaged**
- (1-4) Typ condition: min reference power, typical AC input voltage  
Max condition: max reference power, min AC input voltage
- (2-1) Including PSU size
- (2-2) Including PSU weight
- (2-3) Max condition: Fan is under max RPM(rotation per minute).



**Model No.: 240-Aa**

**Version: S17-56T**

| Product Glance                                 | Value          |        |
|--|----------------|--------|
|  | Low Power      | Normal |
| Crypto Algorithm/Coins                         | SHA256/BTC/BCH |        |
| Hashrate, TH/s                                 | 35.00~50.00    | 56.00  |
| Reference power on wall, <b>Watt</b>           | 1470~2100      | 2520   |
| Reference power efficiency on wall @25°C, J/TH | 42.00          | 45.00  |

| Detailed Characteristics   | Value                 |            |           |                      |
|--|-----------------------|------------|-----------|----------------------|
|  | Min                   | Typ        | Max       |                      |
| <b>Hashrate &amp; Power</b>  |                       |            |           |                      |
| Hashrate, TH/s   | Low Power             |            | 35~50.00  | +3% <sup>(1-1)</sup> |
|  | Normal                |            | 56.00     | 58.95                |
| Power efficiency on wall @25°C, J/TH                                       | Low Power             | 42.00      |           | 46.20                |
|  | Normal                | 45.00      |           | 49.50                |
| Power efficiency on wall @40°C, J/TH                                       | Low Power             | 43.98      |           | 48.38                |
|  | Normal                | 47.42      |           | 52.17                |
| Power on wall, <b>Watt</b> <sup>(1-2)</sup>                                | Low Power             | 1470 ~2100 |           | 2492                 |
|  | Normal                | 2520       |           | 3075                 |
| Power supply AC input voltage, <b>Volt</b> <sup>(1-3)</sup>                |                       | 200        | 220       | 240                  |
| Power supply AC input current, <b>Amp</b> <sup>(1-4)</sup>                 | Low Power             |            | 6.68~9.55 | 12.46                |
|  | Normal                |            | 11.45     | 15.38                |
| Power supply Input AC Frequency Range, <b>Hz</b>                           |                       | 47         | 50        | 63                   |
| <b>Hardware Configuration</b>  |                       |            |           |                      |
| Quantity of hash chips   | 144                   |            |           |                      |
| Quantity of hash boards  | 3                     |            |           |                      |
| Networking connection mode   | RJ45 Ethernet 10/100M |            |           |                      |
| Server Size (Length*Width*Height, w/o package), <b>mm</b> <sup>(2-1)</sup> | 298.2*178.0*296.6     |            |           |                      |
| Net weight, <b>kg</b> <sup>(2-2)</sup>                                     | 9.50                  |            |           |                      |

|   |  |     |    |     |
|---|--|-----|----|-----|
| Noise, dBA @25°C <sup>(2-3)</sup>       |  |     |    | 82  |
| <b>Environmental Requirements</b>       |  |     |    |     |
| Operation temperature, °C               |  | 0   | 25 | 40  |
| Storage temperature, °C                 |  | -20 | 25 | 70  |
| Operation humidity, RH(no condensation) |  | 10% |    | 90% |

**Notes:**

- (1-1) In Low Power Mode, Max Hashrate is about **Typ Hashrate \*103%**
- (1-2) Min condition: 25°C, min J/TH, typical Hashrate  
Max condition: 40°C, max J/TH, max Hashrate
- (1-3) Caution: Wrong input voltage may probably cause server damaged**
- (1-4) Typ condition: min reference power, typical AC input voltage  
Max condition: max reference power, min AC input voltage
- (2-1) Including PSU size
- (2-2) Including PSU weight
- (2-3) Max condition: Fan is under max RPM(rotation per minute).

**Model No.: 240-Aa**  
**Version: S17 Pro-50T**

| Product Glance                                 | Value          |        |           |
|--|----------------|--------|-----------|
|  | Low Power      | Normal | Turbo     |
| Crypto Algorithm/Coins                         | SHA256/BTC/BCH |        |           |
| Hashrate, TH/s                                 | 36~48.00       | 50.00  | 50~62.00  |
| Reference power on wall, Watt                  | 1296~1728      | 1975   | 2250~2790 |
| Reference power efficiency on wall @25°C, J/TH | 36.00          | 39.50  | 45.00     |

| Detailed Characteristics                             | Value     |           |             |                      |
|--|-----------|-----------|-------------|----------------------|
|  | Min       | Typ       | Max         |                      |
| <b>Hashrate &amp; Power</b>                          |           |           |             |                      |
| Hashrate, TH/s                                       | Low Power |           | 36~48.00    | +3% <sup>(1-1)</sup> |
|  | Normal    |           | 50.00       | 52.95                |
|  | Turbo     |           | 50~62.00    | +3% <sup>(1-2)</sup> |
| Power efficiency on wall @25°C, J/TH                 | Low Power | 36.00     |             | 39.60                |
|  | Normal    | 39.50     |             | 43.45                |
|  | Turbo     | 45.00     |             | 49.50                |
| Power efficiency on wall @40°C, J/TH                 | Low Power | 38.30     |             | 42.12                |
|  | Normal    | 41.50     |             | 45.64                |
|  | Turbo     | 47.25     |             | 51.98                |
| Power on wall, Watt <sup>(1-3)</sup>                 | Low Power | 1296~1728 |             | 2082                 |
|  | Normal    | 1975      |             | 2417                 |
|  | Turbo     | 2250~2790 |             | 3319                 |
| Power supply AC input voltage, Volt <sup>(1-4)</sup> |           | 200       | 220         | 240                  |
| Power supply AC input current, Amp <sup>(1-5)</sup>  | Low Power |           | 5.89~7.85   | 10.41                |
|  | Normal    |           | 8.98        | 12.08                |
|  | Turbo     |           | 10.23~12.68 | 16.60                |
| Power supply Input AC Frequency Range, Hz            |           | 47        | 50          | 63                   |
| <b>Hardware Configuration</b>                        |           |           |             |                      |

|  |                              |            |           |            |
|--|------------------------------|------------|-----------|------------|
| Quantity of hash chips   | <b>144</b>                   |            |           |            |
| Quantity of hash boards  | <b>3</b>                     |            |           |            |
| Networking connection mode   | <b>RJ45 Ethernet 10/100M</b> |            |           |            |
| Server Size (Length*Width*Height, w/o package),mm <sup>(2-1)</sup> | <b>298.2*178.0*296.6</b>     |            |           |            |
| Net weight, kg <sup>(2-2)</sup>                                    | <b>9.50</b>                  |            |           |            |
| Noise, dBA @25°C <sup>(2-3)</sup>                                  |                              |            |           | <b>82</b>  |
| <b>Environmental Requirements</b>                                  |                              |            |           |            |
| Operation temperature,°C   |                              | <b>0</b>   | <b>25</b> | <b>40</b>  |
| Storage temperature,°C   |                              | <b>-20</b> | <b>25</b> | <b>70</b>  |
| Operation humidity, RH(no condensation)                            |                              | <b>10%</b> |           | <b>90%</b> |

**Notes:**

- (1-1) In Low Power Mode, Max Hashrate is about **Typ Hashrate \*103%**
- (1-2) In Turbo Mode, Max Hashrate is about **Typ Hashrate \*103%**
- (1-3) Min condition: 25°C, min J/TH, typical Hashrate  
Max condition: 40°C, max J/TH, max Hashrate
- (1-4) Caution: Wrong input voltage may probably cause server damaged**
- (1-5) Typ condition: min reference power, typical AC input voltage  
Max condition: max reference power, min AC input voltage
- (2-1) Including PSU size
- (2-2) Including PSU weight
- (2-3) Max condition: Fan is under max RPM(rotation per minute).

**Model No.: 240-Aa**  
**Version: S17 Pro-53T**

| Product Glance                                 | Value          |        |           |
|--|----------------|--------|-----------|
|  | Low Power      | Normal | Turbo     |
| Crypto Algorithm/Coins                         | SHA256/BTC/BCH |        |           |
| Hashrate, TH/s                                 | 36~48.00       | 53.00  | 53~62.00  |
| Reference power on wall, <b>Watt</b>           | 1296~1728      | 2094   | 2385~2790 |
| Reference power efficiency on wall @25°C, J/TH | 36.00          | 39.50  | 45.00     |

| Detailed Characteristics                                    | Value     |           |             |                      |
|---|-----------|-----------|-------------|----------------------|
|   |           | Min       | Typ         | Max                  |
| <b>Hashrate &amp; Power</b>                                 |           |           |             |                      |
| Hashrate, TH/s  | Low Power |           | 36~48.00    | +3% <sup>(1-1)</sup> |
|   | Normal    |           | 53.00       | 55.95                |
|   | Turbo     |           | 53~62.00    | +3% <sup>(1-2)</sup> |
| Power efficiency on wall @25°C, J/TH                        | Low Power | 36.00     |             | 39.60                |
|   | Normal    | 39.50     |             | 43.45                |
|   | Turbo     | 45.00     |             | 49.50                |
| Power efficiency on wall @40°C, J/TH                        | Low Power | 38.22     |             | 42.05                |
|   | Normal    | 41.73     |             | 45.90                |
|   | Turbo     | 47.99     |             | 52.79                |
| Power on wall, <b>Watt</b> <sup>(1-3)</sup>                 | Low Power | 1296~1728 |             | 2079                 |
|   | Normal    | 2094      |             | 2568                 |
|   | Turbo     | 2385~2790 |             | 3371                 |
| Power supply AC input voltage, <b>Volt</b> <sup>(1-4)</sup> |           | 200       | 220         | 240                  |
| Power supply AC input current, <b>Amp</b> <sup>(1-5)</sup>  | Low Power |           | 5.89~7.85   | 10.40                |
|   | Normal    |           | 9.52        | 12.84                |
|   | Turbo     |           | 10.84~12.68 | 16.86                |
| Power supply Input AC Frequency Range, <b>Hz</b>            |           | 47        | 50          | 63                   |

| Hardware Configuration   |                       |     |    |     |
|--|-----------------------|-----|----|-----|
| Quantity of hash chips   | 144                   |     |    |     |
| Quantity of hash boards  | 3                     |     |    |     |
| Networking connection mode   | RJ45 Ethernet 10/100M |     |    |     |
| Server Size (Length*Width*Height, w/o package),mm <sup>(2-1)</sup> | 298.2*178.0*296.6     |     |    |     |
| Net weight, kg <sup>(2-2)</sup>                                    | 9.50                  |     |    |     |
| Noise, dBA @25°C <sup>(2-3)</sup>                                  |                       |     |    | 82  |
| Environmental Requirements   |                       |     |    |     |
| Operation temperature,°C   |                       | 0   | 25 | 40  |
| Storage temperature,°C   |                       | -20 | 25 | 70  |
| Operation humidity, RH(no condensation)                            |                       | 10% |    | 90% |

**Notes:**

- (1-1) In Low Power Mode, Max Hashrate is about **Typ Hashrate \*103%**
- (1-2) In Turbo Mode, Max Hashrate is about **Typ Hashrate \*103%**
- (1-3) Min condition: 25°C, min J/TH, typical Hashrate  
Max condition: 40°C, max J/TH, max Hashrate
- (1-4) Caution: Wrong input voltage may probably cause server damaged**
- (1-5) Typ condition: min reference power, typical AC input voltage  
Max condition: max reference power, min AC input voltage
- (2-1) Including PSU size
- (2-2) Including PSU weight
- (2-3) Max condition: Fan is under max RPM(rotation per minute).

**Model No.: 240-Aa**

**Version: T17-40T**

| Product Glance                                 | Value          |
|--|----------------|
| Crypto Algorithm/Coins                         | SHA256/BTC/BCH |
| Hashrate, TH/s                                 | 40.00          |
| Reference power on wall, <b>Watt</b>           | 2200           |
| Reference power efficiency on wall @25°C, J/TH | 55.00          |

| Detailed Characteristics   | Value                 |       |       |
|--|-----------------------|-------|-------|
|  | Min                   | Typ   | Max   |
| <b>Hashrate &amp; Power</b>  |                       |       |       |
| Hashrate, TH/s   |                       | 40.00 | 40.45 |
| Power efficiency on wall @25°C, J/TH                                       | 55.00                 |       | 58.85 |
| Power efficiency on wall @40°C, J/TH                                       | 58.26                 |       | 62.34 |
| Power on wall, <b>Watt</b> <sup>(1-1)</sup>                                | 2200                  |       | 2522  |
| Power supply AC input voltage, <b>Volt</b> <sup>(1-2)</sup>                | 200                   | 220   | 240   |
| Power supply AC input current, <b>Amp</b> <sup>(1-3)</sup>                 |                       | 10.00 | 12.61 |
| Power supply Input AC Frequency Range, <b>Hz</b>                           | 47                    | 50    | 63    |
| <b>Hardware Configuration</b>  |                       |       |       |
| Quantity of hash chips   | 90                    |       |       |
| Quantity of hash boards  | 3                     |       |       |
| Networking connection mode   | RJ45 Ethernet 10/100M |       |       |
| Server Size (Length*Width*Height, w/o package), <b>mm</b> <sup>(2-1)</sup> | 298.2*178.0*296.6     |       |       |
| Net weight, <b>kg</b> <sup>(2-2)</sup>                                     | 9.73                  |       |       |
| Noise, <b>dBA</b> @25°C <sup>(2-3)</sup>                                   |                       |       | 82    |
| <b>Environment Requirements</b>  |                       |       |       |
| Operation temperature,°C   | 0                     | 25    | 40    |
| Storage temperature,°C   | -20                   | 25    | 70    |
| Operation humidity, <b>RH</b> (no condensation)                            | 10%                   |       | 90%   |

**Notes:**

- (1-1) Min condition: 25°C, min J/TH, typical Hashrate  
Max condition: 40°C, max J/TH, max Hashrate
- (1-2) Caution: Wrong input voltage may probably cause server damaged**
- (1-3) Typ condition: min reference power, typical AC input voltage  
Max condition: max reference power, min AC input voltage
- (2-1) Including PSU size
- (2-2) Including PSU weight
- (2-3) Max condition: Fan is under max RPM(rotation per minute).



## 2. Setting Up the Server

To set up the server:



The file IPReporter.zip is supported by Microsoft Windows only.

1. Go to the following site:  
<https://shop.bitmain.com/support.htm?pid=00720160906053730999PVD2K0vz0693>
2. Download the following file: IPReporter.zip.
3. Extract the file.



The default DHCP network protocol distributes IP addresses automatically.

4. Right-click **IPReporter.exe** and run it as Administrator.
5. Select one of the following options:
  - Shelf, Step, Position – suitable for farm servers to mark the location of the servers.
  - Default – suitable for home servers.
6. Click **Start**.

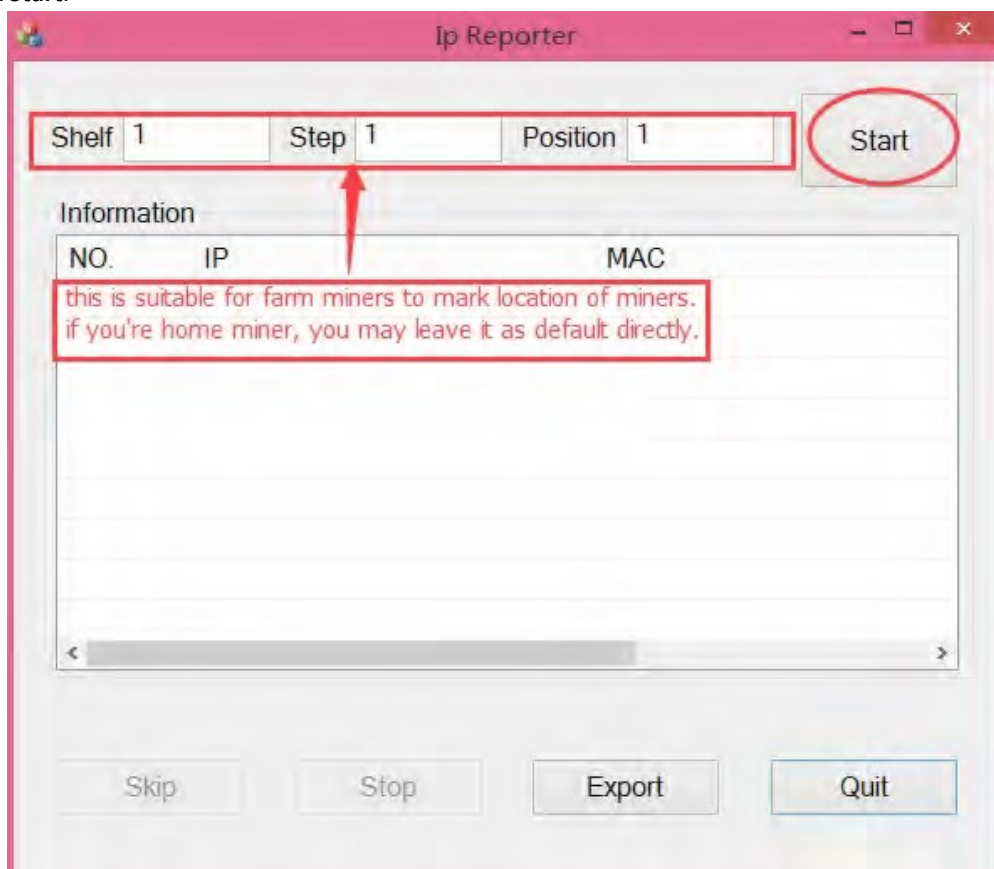

- On the controller board, click the IP Report button. Hold it down until it beeps (about 5 seconds).

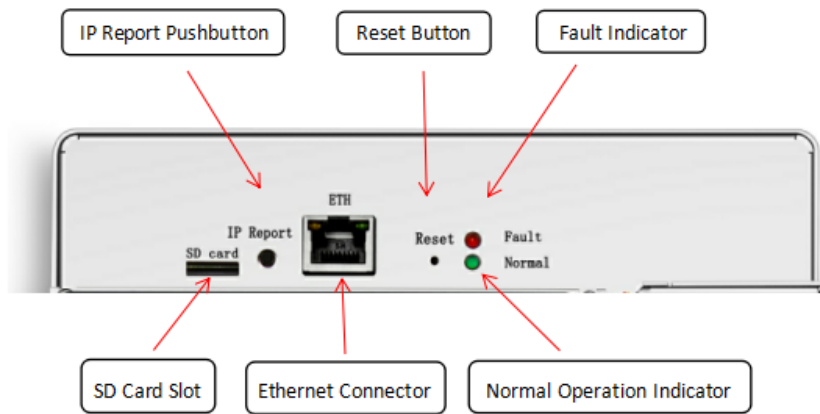

The IP address will be displayed in a window on your computer screen.

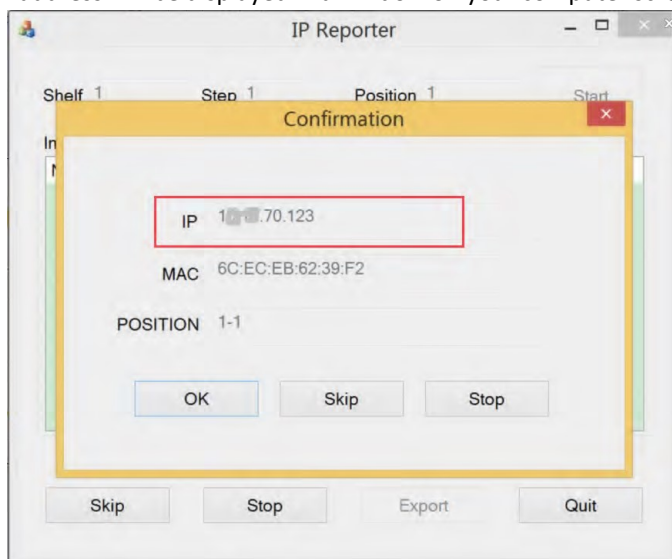

- In your web browser, enter the IP address provided.
- Proceed to login using root for both the username and password.
- In the Network section, you can assign a DHCP IP address (optional).
- Click **Save & Apply**.

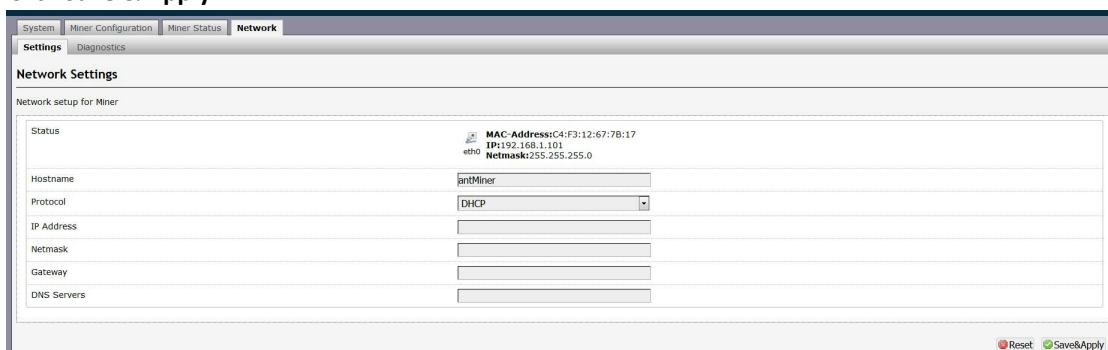

## 3. Configuring the Server

### Setting Up the Pool

To configure the server:

1. click **General Settings**.

**S17 Server:**

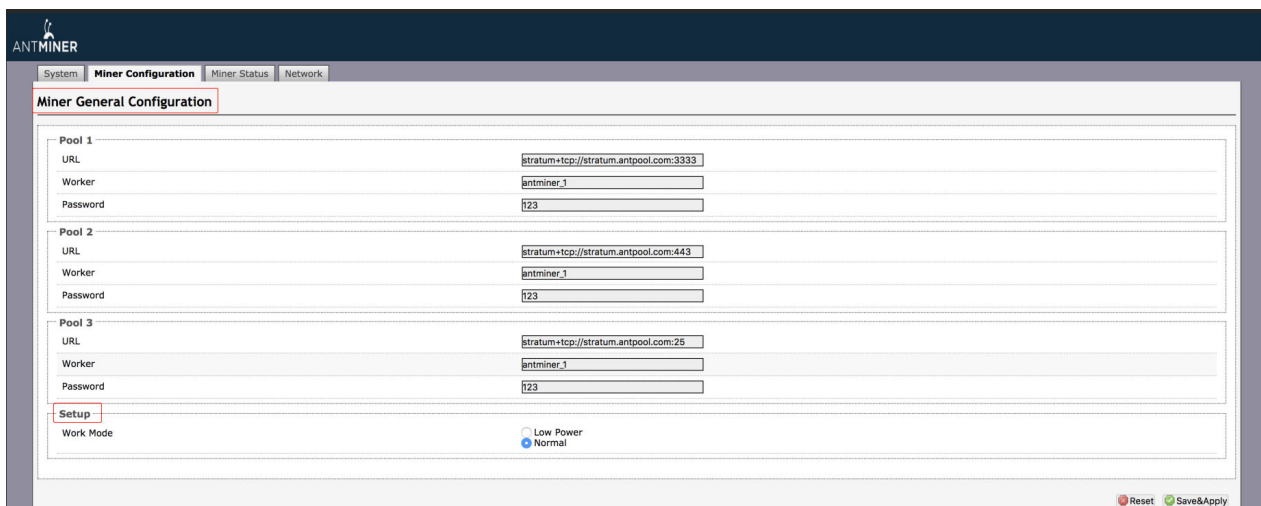

The screenshot shows the 'Miner General Configuration' page for the S17 Server. The page has a dark blue header with the 'ANTMINER' logo and navigation tabs for 'System', 'Miner Configuration', 'Miner Status', and 'Network'. The 'Miner Configuration' tab is active. The main content area is titled 'Miner General Configuration' and contains three pool configuration sections (Pool 1, Pool 2, Pool 3) and a 'Setup' section. Each pool section has fields for 'URL', 'Worker', and 'Password'. The 'Setup' section has a 'Work Mode' field with radio buttons for 'Low Power', 'Normal', and 'Turbo'. The 'Normal' mode is selected. At the bottom right, there are 'Reset' and 'Save&Apply' buttons.

| Pool   | URL                                    | Worker     | Password |
|--------|--|------------|----------|
| Pool 1 | stratum+tcp://stratum.antpool.com:3333 | antminer_1 | f23      |
| Pool 2 | stratum+tcp://stratum.antpool.com:443  | antminer_1 | f23      |
| Pool 3 | stratum+tcp://stratum.antpool.com:25   | antminer_1 | f23      |

Setup  
Work Mode:  Low Power  Normal  Turbo

**S17 Pro Server:**

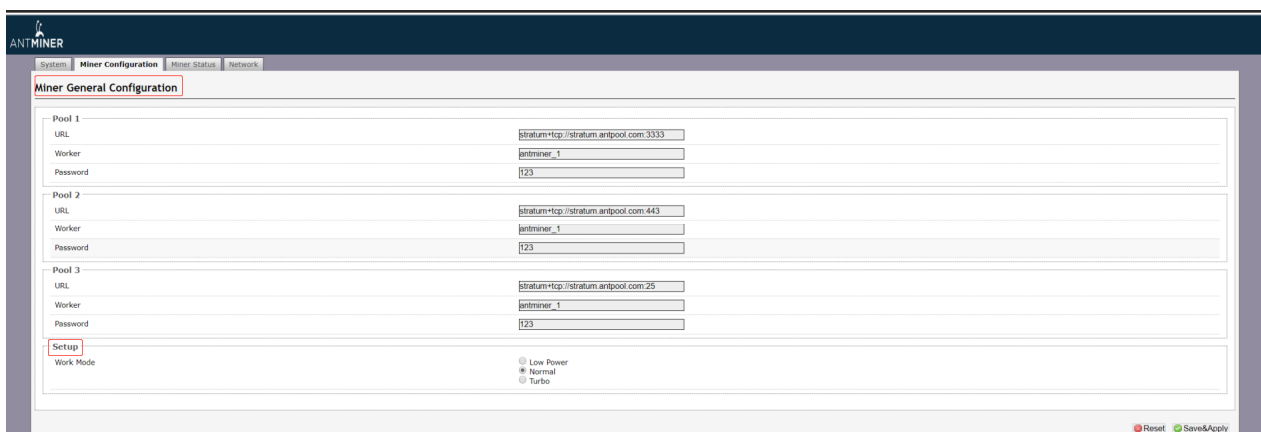



The screenshot shows the 'Miner General Configuration' page for the S17 Pro Server. The page has a dark blue header with the 'ANTMINER' logo and navigation tabs for 'System', 'Miner Configuration', 'Miner Status', and 'Network'. The 'Miner Configuration' tab is active. The main content area is titled 'Miner General Configuration' and contains three pool configuration sections (Pool 1, Pool 2, Pool 3) and a 'Setup' section. Each pool section has fields for 'URL', 'Worker', and 'Password'. The 'Setup' section has a 'Work Mode' field with radio buttons for 'Low Power', 'Normal', and 'Turbo'. The 'Normal' mode is selected. At the bottom right, there are 'Reset' and 'Save&Apply' buttons.

| Pool   | URL                                    | Worker     | Password |
|--------|--|------------|----------|
| Pool 1 | stratum+tcp://stratum.antpool.com:3333 | antminer_1 | f23      |
| Pool 2 | stratum+tcp://stratum.antpool.com:443  | antminer_1 | f23      |
| Pool 3 | stratum+tcp://stratum.antpool.com:25   | antminer_1 | f23      |

Setup  
Work Mode:  Low Power  Normal  Turbo

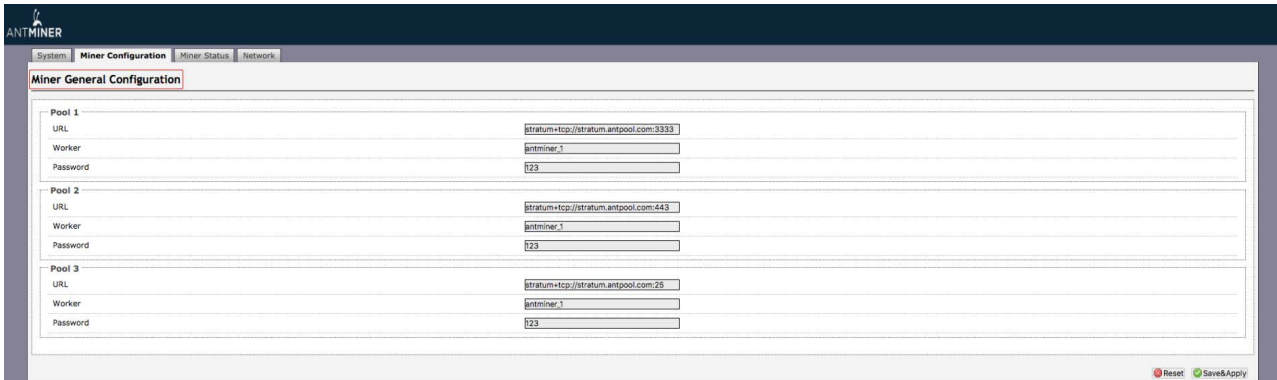
**T17 Server:**



 **Note:** There are three modes of Hashrate which u may adjust for S17 Pro server: Low Power mode, Normal Mode and Turbo mode (High Performance Mode); two modes for S17 server: Low Power mode and Normal mode. Power consumption varies with different mode. Please refer to the specifications above for more details.

2. Set the options according to the following table:

| Option   | Description  |
|----------|--|
| Pool URL | Enter the URL of your desired pool. <div style="border: 1px solid black; padding: 10px; margin-top: 10px;">  <p>The S17, S17 Pro, T17 servers can be set up with three mining pools, with decreasing priority from the first pool (pool 1) to the third pool (pool 3).<br/>The pools with low priority will only be used if all higher priority pools are offline.</p> </div> |
| Worker   | Your worker ID on the selected pool.   |
| Password | The password for your selected worker.   |

3. Click Save & Apply to save and restart the server.

## 4. Monitoring Your server

To check the operating status of your server:

1. Click the status marked below.

Here is an example of S17-53T server running under Normal mode:

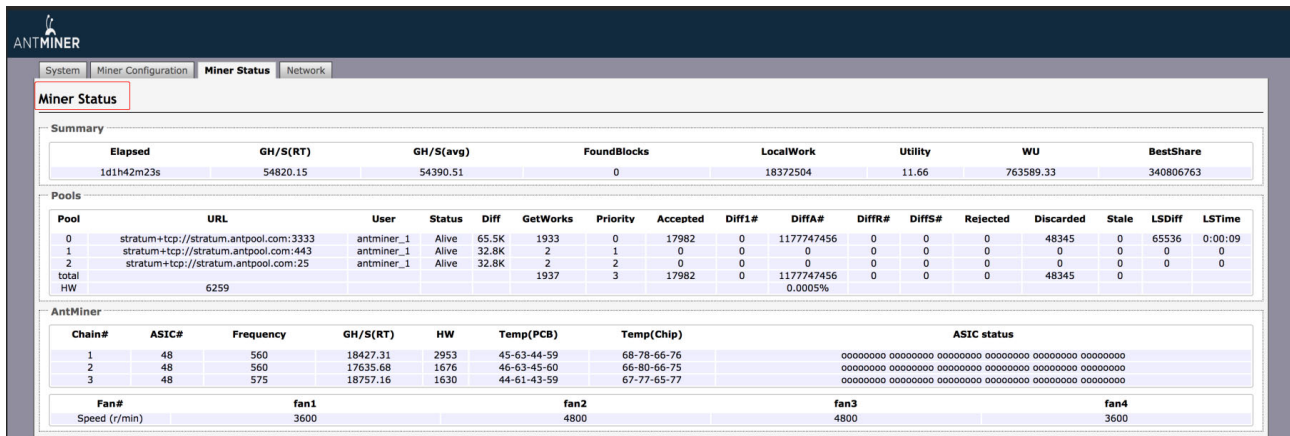

The screenshot shows the 'Miner Status' page with the following data:

| Summary    |          |           |             |           |         |           |           |  |  |  |  |  |  |  |  |
|------------|----------|-----------|-------------|-----------|---------|-----------|-----------|--|--|--|--|--|--|--|--|
| Elapsed    | GH/S(RT) | GH/S(avg) | FoundBlocks | LocalWork | Utility | WU        | BestShare |  |  |  |  |  |  |  |  |
| 1d1h42m23s | 54820.15 | 54390.51  | 0           | 18372504  | 11.66   | 763589.33 | 340806763 |  |  |  |  |  |  |  |  |

| Pools |  |            |        |       |          |          |          |        |            |        |        |          |           |       |        |         |
|-------|--|------------|--------|-------|----------|----------|----------|--------|------------|--------|--------|----------|-----------|-------|--------|---------|
| Pool  | URL                                    | User       | Status | Diff  | GetWorks | Priority | Accepted | Diff1# | DiffA#     | DiffR# | DiffS# | Rejected | Discarded | Stale | LSDiff | LSTime  |
| 0     | stratum+tcp://stratum.antpool.com:3333 | antminer_1 | Alive  | 65.5K | 1933     | 0        | 17982    | 0      | 1177747456 | 0      | 0      | 0        | 48345     | 0     | 65536  | 0:00:09 |
| 1     | stratum+tcp://stratum.antpool.com:443  | antminer_1 | Alive  | 32.8K | 2        | 1        | 0        | 0      | 0          | 0      | 0      | 0        | 0         | 0     | 0      | 0       |
| 2     | stratum+tcp://stratum.antpool.com:25   | antminer_1 | Alive  | 32.8K | 2        | 2        | 0        | 0      | 0          | 0      | 0      | 0        | 0         | 0     | 0      | 0       |
| total |  |            |        |       | 1937     | 3        | 17982    | 0      | 1177747456 | 0      | 0      | 0        | 48345     | 0     |        |         |
| HW    | 6259                                   |            |        |       |          |          |          |        | 0.0005%    |        |        |          |           |       |        |         |

  

| AntMiner |       |           |          |      |             |             |   |  |  |  |  |  |  |  |  |
|----------|-------|-----------|----------|------|-------------|-------------|---|--|--|--|--|--|--|--|--|
| Chain#   | ASIC# | Frequency | GH/S(RT) | HW   | Temp(PCB)   | Temp(Chip)  | ASIC status   |  |  |  |  |  |  |  |  |
| 1        | 48    | 560       | 18427.31 | 2953 | 45-63-44-59 | 68-78-66-76 | 00000000 00000000 00000000 00000000 00000000 00000000 |  |  |  |  |  |  |  |  |
| 2        | 48    | 560       | 17635.68 | 1676 | 46-63-45-60 | 66-80-66-75 | 00000000 00000000 00000000 00000000 00000000 00000000 |  |  |  |  |  |  |  |  |
| 3        | 48    | 575       | 18757.16 | 1630 | 44-61-43-59 | 67-77-65-77 | 00000000 00000000 00000000 00000000 00000000 00000000 |  |  |  |  |  |  |  |  |

| Fan#          |      |      |      |      |
|---------------|------|------|------|------|
| Speed (r/min) | fan1 | fan2 | fan3 | fan4 |
|               | 3600 | 4800 | 4800 | 3600 |

Here is an example of S17 Pro- 53T server running under Turbo mode:

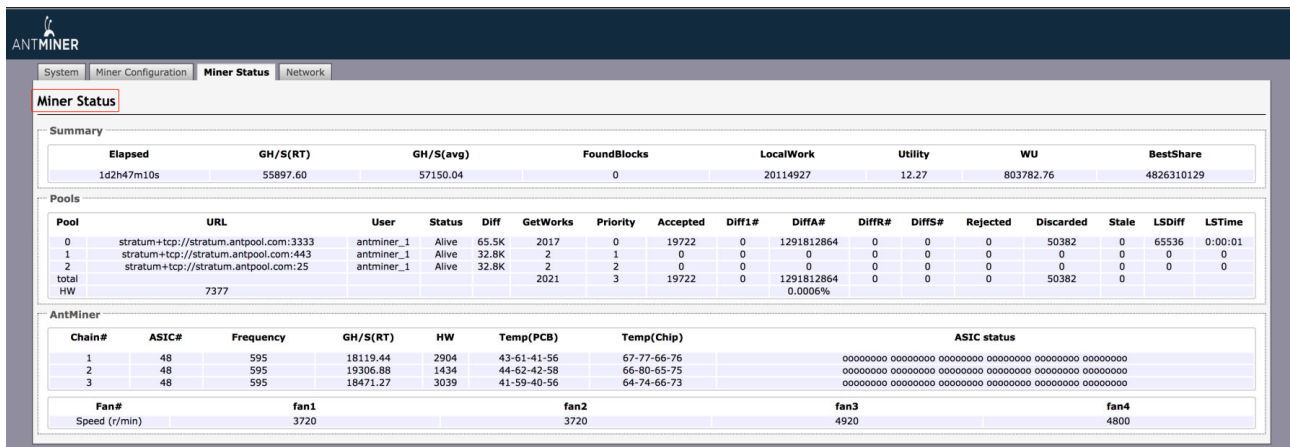

The screenshot shows the 'Miner Status' page with the following data:

| Summary    |          |           |             |           |         |           |            |  |  |  |  |  |  |  |  |
|------------|----------|-----------|-------------|-----------|---------|-----------|------------|--|--|--|--|--|--|--|--|
| Elapsed    | GH/S(RT) | GH/S(avg) | FoundBlocks | LocalWork | Utility | WU        | BestShare  |  |  |  |  |  |  |  |  |
| 1d2h47m10s | 55897.60 | 57150.04  | 0           | 20114927  | 12.27   | 803782.76 | 4826310129 |  |  |  |  |  |  |  |  |

| Pools |  |            |        |       |          |          |          |        |            |        |        |          |           |       |        |         |
|-------|--|------------|--------|-------|----------|----------|----------|--------|------------|--------|--------|----------|-----------|-------|--------|---------|
| Pool  | URL                                    | User       | Status | Diff  | GetWorks | Priority | Accepted | Diff1# | DiffA#     | DiffR# | DiffS# | Rejected | Discarded | Stale | LSDiff | LSTime  |
| 0     | stratum+tcp://stratum.antpool.com:3333 | antminer_1 | Alive  | 65.5K | 2017     | 0        | 19722    | 0      | 1291812864 | 0      | 0      | 0        | 50382     | 0     | 65536  | 0:00:01 |
| 1     | stratum+tcp://stratum.antpool.com:443  | antminer_1 | Alive  | 32.8K | 2        | 1        | 0        | 0      | 0          | 0      | 0      | 0        | 0         | 0     | 0      | 0       |
| 2     | stratum+tcp://stratum.antpool.com:25   | antminer_1 | Alive  | 32.8K | 2        | 2        | 0        | 0      | 0          | 0      | 0      | 0        | 0         | 0     | 0      | 0       |
| total |  |            |        |       | 2021     | 3        | 19722    | 0      | 1291812864 | 0      | 0      | 0        | 50382     | 0     |        |         |
| HW    | 7377                                   |            |        |       |          |          |          |        | 0.0006%    |        |        |          |           |       |        |         |

  

| AntMiner |       |           |          |      |             |             |   |  |  |  |  |  |  |  |  |
|----------|-------|-----------|----------|------|-------------|-------------|---|--|--|--|--|--|--|--|--|
| Chain#   | ASIC# | Frequency | GH/S(RT) | HW   | Temp(PCB)   | Temp(Chip)  | ASIC status   |  |  |  |  |  |  |  |  |
| 1        | 48    | 595       | 18119.44 | 2904 | 43-61-41-56 | 67-77-66-76 | 00000000 00000000 00000000 00000000 00000000 00000000 |  |  |  |  |  |  |  |  |
| 2        | 48    | 595       | 19306.88 | 1434 | 44-62-42-58 | 66-80-65-75 | 00000000 00000000 00000000 00000000 00000000 00000000 |  |  |  |  |  |  |  |  |
| 3        | 48    | 595       | 18471.27 | 3039 | 41-59-40-56 | 64-74-66-73 | 00000000 00000000 00000000 00000000 00000000 00000000 |  |  |  |  |  |  |  |  |

| Fan#          |      |      |      |      |
|---------------|------|------|------|------|
| Speed (r/min) | fan1 | fan2 | fan3 | fan4 |
|               | 3720 | 3720 | 4920 | 4800 |

Here is an example of T17-40T server:

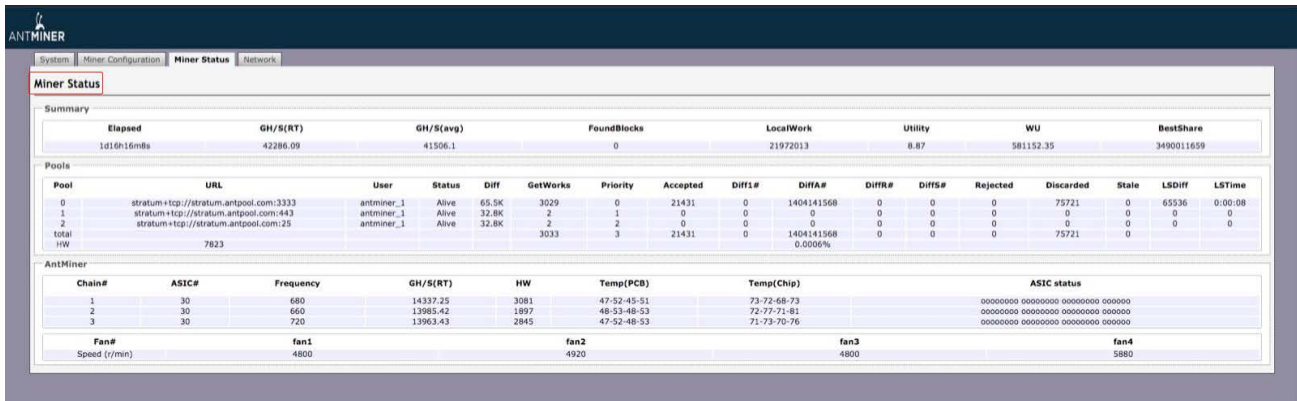

The screenshot shows the 'Miner Status' page with the following data:

| Summary    |          |           |             |           |         |           |            |  |  |
|------------|----------|-----------|-------------|-----------|---------|-----------|------------|--|--|
| Elapsed    | GH/S(RT) | GH/S(ava) | FoundBlocks | LocalWork | Utility | WU        | BestShare  |  |  |
| 1d16h16m8s | 42286.09 | 41506.1   | 0           | 21972013  | 8.87    | 581152.35 | 3490011659 |  |  |

| Pool  | URL                                    | User       | Status | Diff  | GetWorks | Priority | Accepted | Diff1# | DiffA#     | DiffR# | DiffS# | Rejected | Discarded | Stale | LSDiff | LSTime  |
|-------|--|------------|--------|-------|----------|----------|----------|--------|------------|--------|--------|----------|-----------|-------|--------|---------|
| 0     | stratum+tcp://stratum.antpool.com:3333 | antminer_1 | Alive  | 65.5K | 3029     | 0        | 21431    | 0      | 1404:41568 | 0      | 0      | 0        | 75721     | 0     | 65536  | 0:00:08 |
| 1     | stratum+tcp://stratum.antpool.com:443  | antminer_1 | Alive  | 32.8K | 2        | 1        | 0        | 0      | 0          | 0      | 0      | 0        | 0         | 0     | 0      | 0       |
| 2     | stratum+tcp://stratum.antpool.com:25   | antminer_1 | Alive  | 32.8K | 2        | 2        | 0        | 0      | 0          | 0      | 0      | 0        | 0         | 0     | 0      | 0       |
| total |  |            |        |       | 3033     | 3        | 21431    | 0      | 1404:41568 | 0      | 0      | 0        | 75721     | 0     |        |         |
| HW    | 7823                                   |            |        |       |          |          |          |        |            |        |        |          |           |       |        | 0.0000% |

| Chain# | ASIC# | Frequency | GH/S(RT) | HW   | Temp(PCB)   | Temp(Chip)  | ASIC status                         |
|--------|-------|-----------|----------|------|-------------|-------------|-------------------------------------|
| 1      | 30    | 680       | 14337.25 | 3081 | 47-52-45-51 | 73-72-68-73 | 00000000 00000000 00000000 00000000 |
| 2      | 30    | 660       | 13865.42 | 1897 | 48-53-48-53 | 72-77-71-81 | 00000000 00000000 00000000 00000000 |
| 3      | 30    | 720       | 13963.43 | 2845 | 47-52-48-53 | 71-73-70-76 | 00000000 00000000 00000000 00000000 |

| Fan# | Speed (r/min) | fan1 | fan2 | fan3 | fan4 |
|------|---------------|------|------|------|------|
|      | 4800          | 4800 | 4920 | 4800 | 5880 |

Note: The S17, S17 Pro, T17 servers are with automatic frequency. Firmware will stop running when the Temp (PCB) reaches to 75°C or Temp(chips) reaches to 100°C, there will be an error message “Fatal Error: Temperature is too high!” shown in the bottom of kernel log page.

2. Monitor your server according to the descriptions in the following table:

| Option      | Description  |
|-------------|--|
| ASIC#       | Number of chips detected in the chain.   |
| Frequency   | ASIC frequency setting.  |
| GH/S(RT)    | Hash rate of each hash board (GH/s).   |
| Temp(PCB)   | Temperature of each hash board (°C). (Applied only to server with fixed frequency).  |
| Temp(Chip)  | Temperature of the chips on each hash board (°C).  |
| ASIC status | One of the following statuses will appear: <ul style="list-style-type: none"> <li>● O - indicates OK</li> <li>● X - indicates error</li> <li>● - - indicates dead</li> </ul> |

## 5. Administering Your Server

### 5.1 Checking Your Firmware Version

To check your firmware version:

1. In **System**, click the **Overview** tab.
2. **File System Version** displays the date of the firmware your server uses. In the examples below, the servers are respectively using firmware version 20190408 and 20190426.

**S17 Server:**

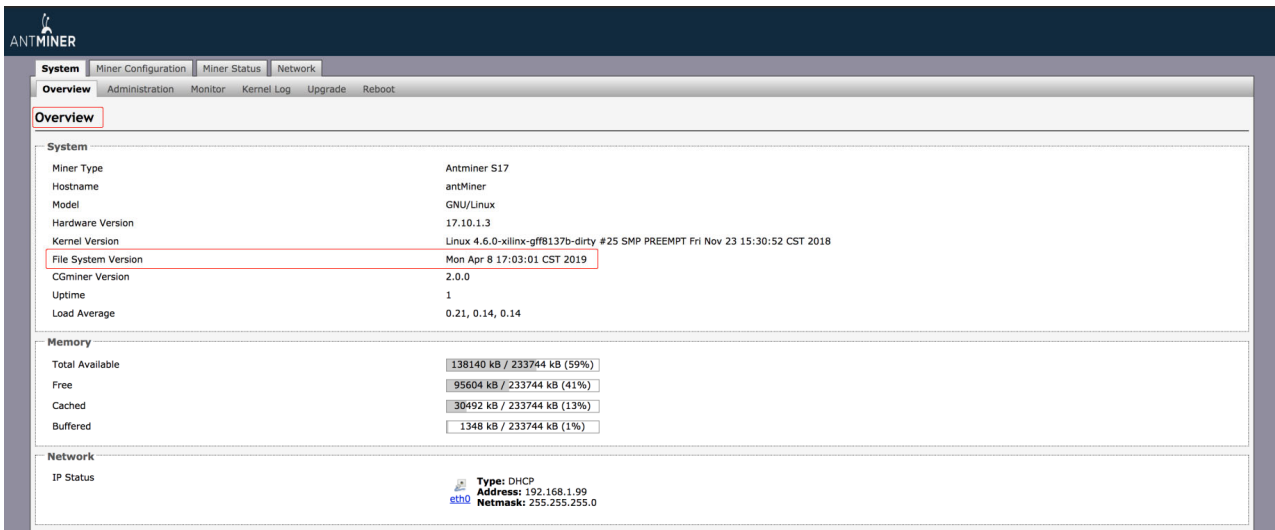

The screenshot shows the Antminer S17 Overview page. The 'File System Version' is highlighted with a red box and shows 'Mon Apr 8 17:03:01 CST 2019'. Other system information includes: Miner Type: Antminer S17, Hostname: antMiner, Model: GNU/Linux, Hardware Version: 17.10.1.3, Kernel Version: Linux 4.6.0-xilinx-gf8137b-dirty #25 SMP PREEMPT Fri Nov 23 15:30:52 CST 2018, CGminer Version: 2.0.0, Uptime: 1, Load Average: 0.21, 0.14, 0.14. Memory usage is shown as 138140 kB / 233744 kB (59%) available, 95604 kB / 233744 kB (41%) free, 30492 kB / 233744 kB (13%) cached, and 1348 kB / 233744 kB (1%) buffered. Network status shows IP Status: Type: DHCP, Address: 192.168.1.99, Netmask: 255.255.255.0.

**S17 Pro Server:**

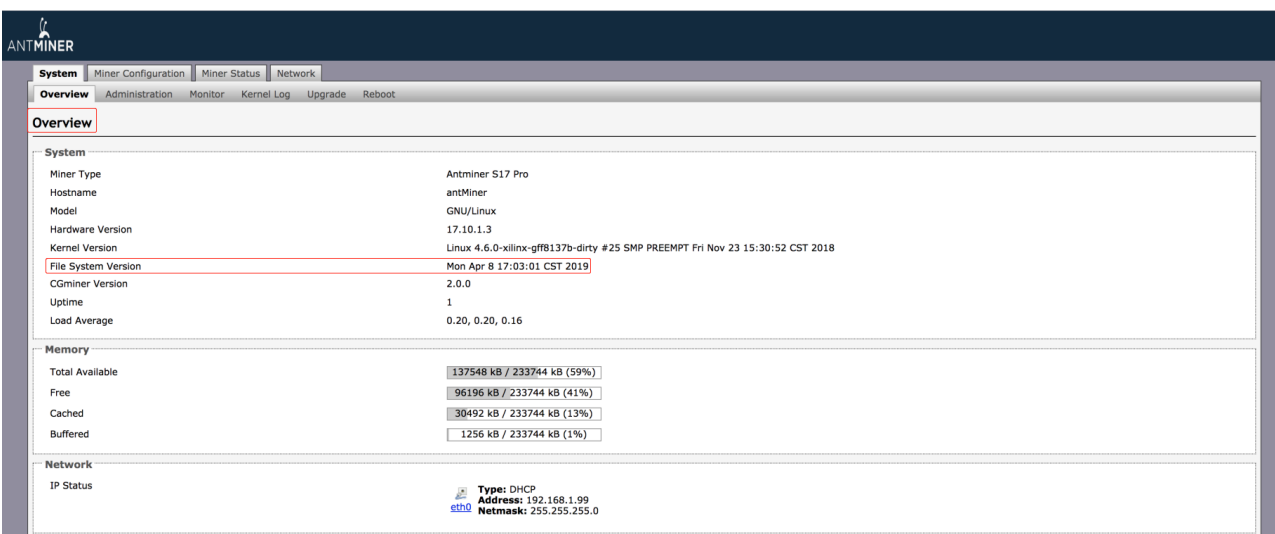

The screenshot shows the Antminer S17 Pro Overview page. The 'File System Version' is highlighted with a red box and shows 'Mon Apr 8 17:03:01 CST 2019'. Other system information includes: Miner Type: Antminer S17 Pro, Hostname: antMiner, Model: GNU/Linux, Hardware Version: 17.10.1.3, Kernel Version: Linux 4.6.0-xilinx-gf8137b-dirty #25 SMP PREEMPT Fri Nov 23 15:30:52 CST 2018, CGminer Version: 2.0.0, Uptime: 1, Load Average: 0.20, 0.20, 0.16. Memory usage is shown as 137548 kB / 233744 kB (59%) available, 96196 kB / 233744 kB (41%) free, 30492 kB / 233744 kB (13%) cached, and 1256 kB / 233744 kB (1%) buffered. Network status shows IP Status: Type: DHCP, Address: 192.168.1.99, Netmask: 255.255.255.0.

**T17 Server:**

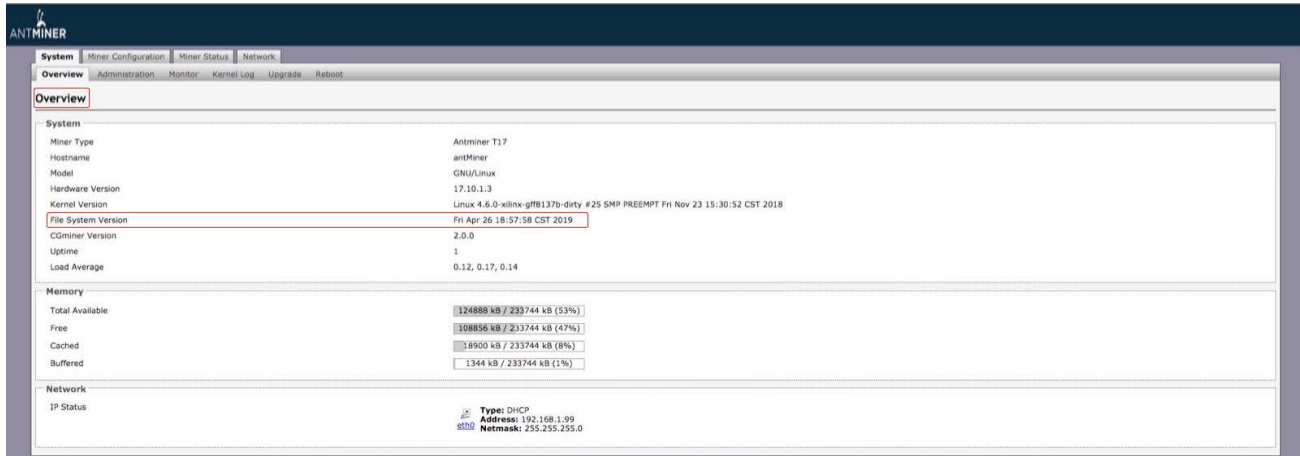

**5.2 Upgrading Your System**

 Make sure that the S17, S17 Pro, T17 servers remain powered during the upgrade process. If power fails before the upgrade is completed, you will need to return it to Bitmain for repair.

**To upgrade the server's firmware:**

1. In System, click **Upgrade**.

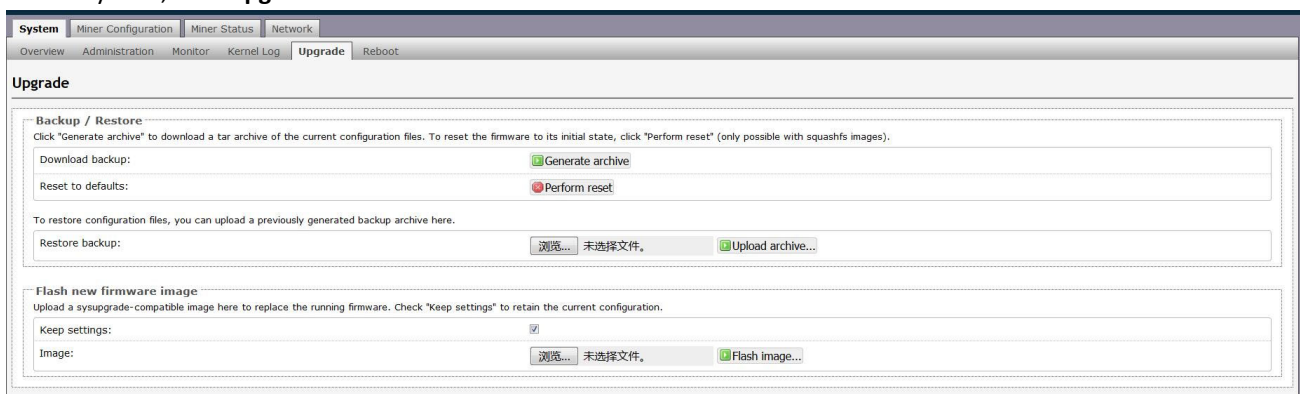

2. For **Keep Settings**:
  - Select the check box to keep your current settings (default).
  - Clear the check box to reset the server to default settings.
3. Click the  (**Browse**) button and navigate to the upgrade file. Select the upgrade file, then click **Flash image**. A message appears notifying you if the S17, S17 Pro, T17 firmwares can be upgraded and if yes, will then proceed to flash the image.



4. When the upgrade is completed, the following message appears:

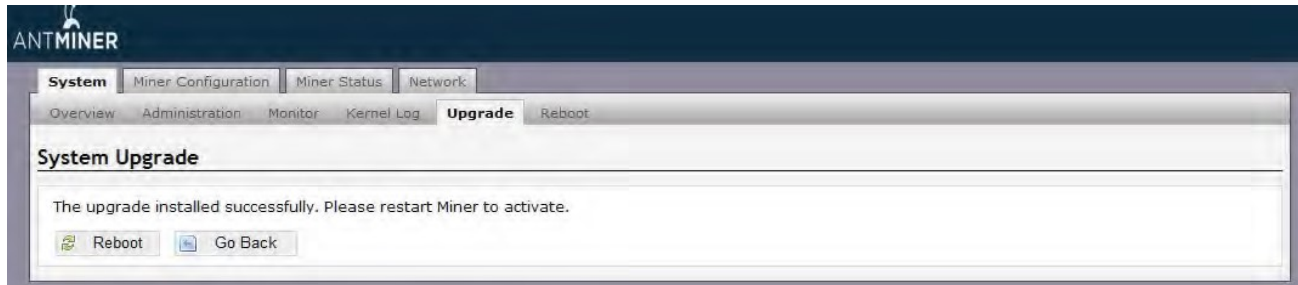

5. Click one of the following options:

- **Reboot** - to restart the server with the new firmware.
- **Go Back** - to continue mining with the current firmware. The server will load the new firmware next time when it is restarted.

### 5.3 Modifying Your Password

To change your login password:

1. In **System**, click the **Administration** tab.
2. Set your new password, then click **Save & Apply**.

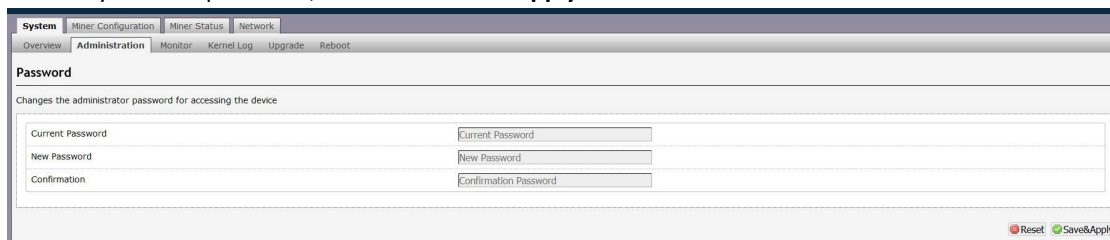

### 5.4 Restoring Initial Settings

To restore your initial settings

1. Turn on the server and let it run for 5 minutes.
2. On the controller front panel, press and hold the **Reset** button for 10 seconds.



Resetting your server will reboot it and restore its default settings. The red LED will automatically flash once every 15 seconds if the reset is operated successfully.

## Environmental Requirements

Please run your server in accordance with the following requirements

### 1. Basic Environmental Requirements:

#### 1.1. Climatic Conditions:

| Description           | Requirement               |
|-----------------------|---------------------------|
| Operating Temperature | 0-40°C                    |
| Operating Humidity    | 10-90%RH (non-condensing) |
| Storage Temperature   | -20-70°C                  |
| Storage Humidity      | 5-95%RH (non-condensing)  |
| Altitude              | <2000m                    |

#### 1.2. Site Requirements of the Server Running Room:

Please keep the server running room away from industrial pollution sources:

For heavy pollution sources such as smelters and coal mines, the distance should be more than 5km.

For moderate pollution sources such as chemical industries, rubber and electroplating industries, the distance should be more than 3.7km.

For light pollution sources such as food factories and leather processing factories, the distance should be more than 2km.

If unavoidable, the site should be chosen in the perennial upwind direction of the pollution source.

Please do not set your location within 3.7km from the seaside or the salt lake. If unavoidable, it should be built as airtight as possible, equipped with air conditioning for cooling.

#### 1.3. Electromagnetic Environmental Conditions:

Please keep your site away from transformers, high-voltage cables, transmission lines and high-current equipment, for example, there should be no high-power AC transformers (>10KA) within 20 meters, and no high-voltage power lines within 50 meters.

Please keep your site away from high-power radio transmitters, for example, there should be no high-power radio transmitters (>1500W) within 100 meters.

### 2. Other Environmental Requirements :

The server running room shall be free of explosive, conductive, magnetically conductive and corrosive dust. The requirements of mechanical active substances are shown below:

#### 2.1 Requirements of Mechanical Active Substances

| Mechanical Active Substance | Requirement                            |
|-----------------------------|--|
| Sand                        | $\leq 30\text{mg}/\text{m}^3$          |
| Dust (suspended)            | $\leq 0.2\text{mg}/\text{m}^3$         |
| Dust (deposited)            | $\leq 1.5\text{mg}/\text{m}^2\text{h}$ |

## 2.2 Requirements of Corrosive Gas

| Corrosive Gas    | Unit | Concentration |
|------------------|------|---------------|
| H <sub>2</sub> S | ppb  | < 3           |
| SO <sub>2</sub>  | ppb  | < 10          |
| Cl <sub>2</sub>  | ppb  | < 1           |
| NO <sub>2</sub>  | ppb  | < 50          |
| HF               | ppb  | < 1           |
| NH <sub>3</sub>  | ppb  | < 500         |
| O <sub>3</sub>   | ppb  | < 2           |

Note: ppb (part per billion) refers to the unit of concentration , 1ppb stands for the volume ratio of part per billion.

**Regulations:**

**FCC Notice (FOR FCC CERTIFIED MODELS):**

This device complies with part 15 of the FCC Rules. Operation is subject to the following two conditions: (1) This device may not cause harmful interference, and (2) this device must accept any interference received, including interference that may cause undesired operation.

**Note:**

This equipment has been tested and found to comply with the limits for a Class A digital device, pursuant to part 15 of the FCC Rules. These limits are designed to provide reasonable protection against harmful interference when the equipment is operated in a commercial environment. This equipment generates, uses, and can radiate radio frequency energy and, if not installed and used in accordance with the instruction manual, may cause harmful interference to radio communications. Operation of this equipment in a residential area is likely to cause harmful interference in which case the user will be required to correct the interference at his own expense.

**EU WEEE: Disposal of Waste Equipment by Users in Private Household in the European Union**



This symbol on the product or on its packaging indicates that this product must not be disposed of with your other household waste. Instead, it is your responsibility to dispose of your waste equipment by handing it over to a designated collection point for the recycling of waste electrical and electronic equipment. The separate collection and recycling of your waste equipment at the time of disposal will help to conserve natural resources and ensure that it is recycled in a manner that protects human health and the environment. For more information about where you can drop off your waste equipment for recycling, please contact your local city office, your household waste disposal service or the shop where you purchased the product.

**台灣 ROHS:**

設備名稱: S17,S17 Pro, T17 服務器, 型號: 240-Aa

| 單元  | 有害物質      |           |           |               |               |                 |
|---|-----------|-----------|-----------|---------------|---------------|-----------------|
|   | 鉛<br>(Pb) | 汞<br>(Hg) | 鎘<br>(Cd) | 六價鉻<br>(Cr+6) | 多溴聯苯<br>(PBB) | 多溴二苯醚<br>(PBDE) |
| 外殼  | ○         | ○         | ○         | ○             | ○             | ○               |
| 電路板組件   | —         | ○         | ○         | ○             | ○             | ○               |
| 其他線材  | —         | ○         | ○         | ○             | ○             | ○               |
| 備考 1. “超出 0.1 wt %” 及 “超出 0.01 wt %” 係指限用物質之百分比含量超出百分比含量基準值。<br>備考 2. “○” 係指該項限用物質之百分比含量未超出百分比含量基準值。<br>備考 3. “—” 係指該項限用物質為排除項目 |           |           |           |               |               |                 |